

Please check the examination details below before entering your candidate information

Candidate surname

Other names

Centre Number

Candidate Number

Pearson Edexcel
Level 1/Level 2 GCSE (9–1)

--	--	--	--	--

--	--	--	--	--

Tuesday 19 May 2020

Morning (Time: 1 hour 30 minutes)

Paper Reference **1MA1/1H**

Mathematics

Paper 1 (Non-Calculator)
Higher Tier

You must have: Ruler graduated in centimetres and millimetres, protractor, pair of compasses, pen, HB pencil, eraser.
Tracing paper may be used.

Total Marks

Instructions

- Use **black** ink or ball-point pen.
- **Fill in the boxes** at the top of this page with your name, centre number and candidate number.
- Answer **all** questions.
- Answer the questions in the spaces provided – *there may be more space than you need.*
- You must **show all your working**.
- Diagrams are **NOT** accurately drawn, unless otherwise indicated.
- **Calculators may not be used.**



Information

- The total mark for this paper is 80
- The marks for **each** question are shown in brackets – *use this as a guide as to how much time to spend on each question.*

Advice

- Read each question carefully before you start to answer it.
- Keep an eye on the time.
- Try to answer every question.
- Check your answers if you have time at the end.

Turn over ►

P62277RA

©2020 Pearson Education Ltd.

1/1/1/1/



P 6 2 2 7 7 R A 0 1 2 0



Pearson

Answer ALL questions.

Write your answers in the spaces provided.

You must write down all the stages in your working.

- 1** The first five terms of an arithmetic sequence are

1 4 7 10 13

Write down an expression, in terms of n , for the n th term of this sequence.

.....
(Total for Question 1 is 2 marks)

- 2** Show that

$$2\frac{1}{3} \times 3\frac{3}{4} = 8\frac{3}{4}$$

.....
(Total for Question 2 is 3 marks)

DO NOT WRITE IN THIS AREA

DO NOT WRITE IN THIS AREA

DO NOT WRITE IN THIS AREA



DO NOT WRITE IN THIS AREA

DO NOT WRITE IN THIS AREA

DO NOT WRITE IN THIS AREA

3 The diagram shows four graphs.

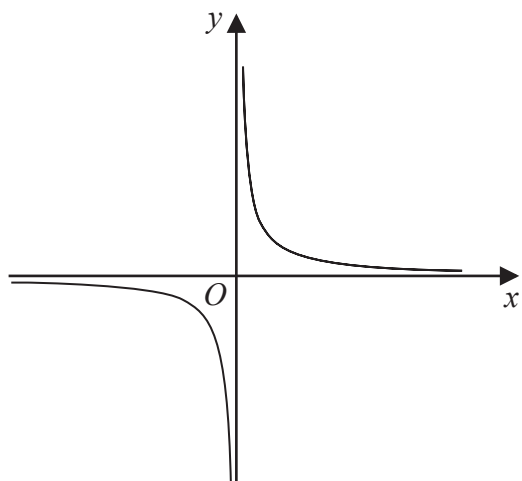

Graph A

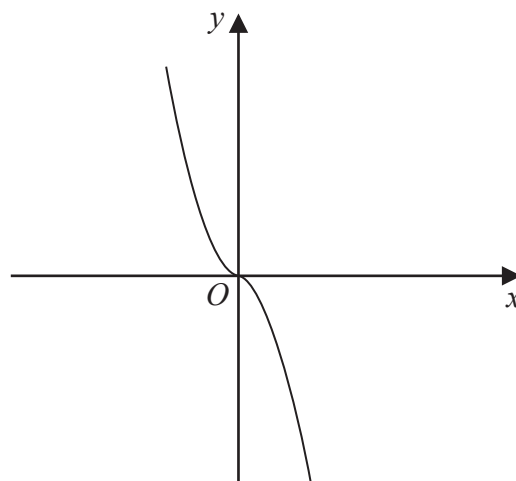

Graph B

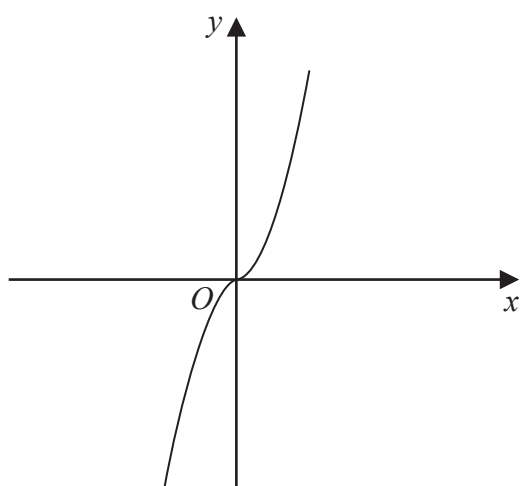

Graph C

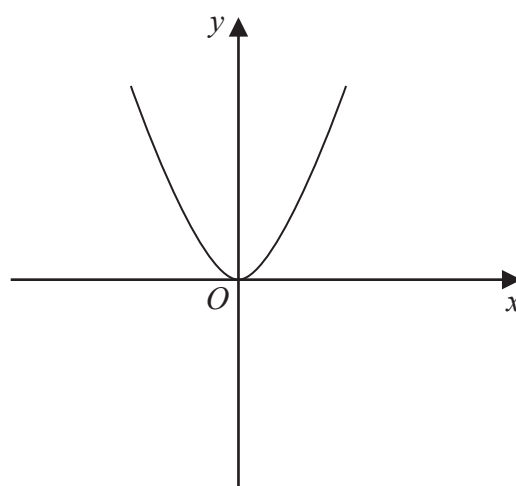

Graph D

Each of the equations in the table is the equation of one of the graphs.

Complete the table.

Equation	Letter of graph
$y = -x^3$	
$y = x^3$	
$y = x^2$	
$y = \frac{1}{x}$	

(Total for Question 3 is 2 marks)



P 6 2 2 7 7 R A 0 3 2 0

4 The diagram shows four triangles.

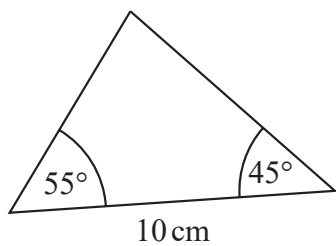

Triangle A

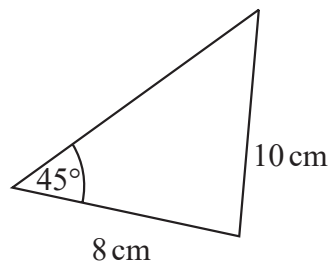

Triangle B

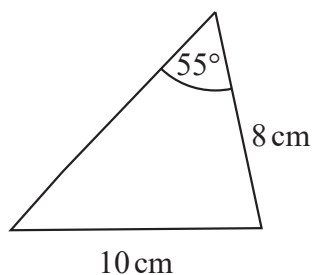

Triangle C

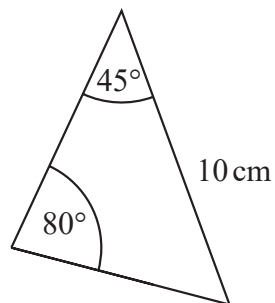

Triangle D

Two of these triangles are congruent.

Write down the letters of these two triangles.

..... and

(Total for Question 4 is 1 mark)

5 Sean pays £10 for 24 chocolate bars.

He sells all 24 chocolate bars for 50p each.

Work out Sean's percentage profit.

..... %

(Total for Question 5 is 3 marks)



6 ADC is a triangle.

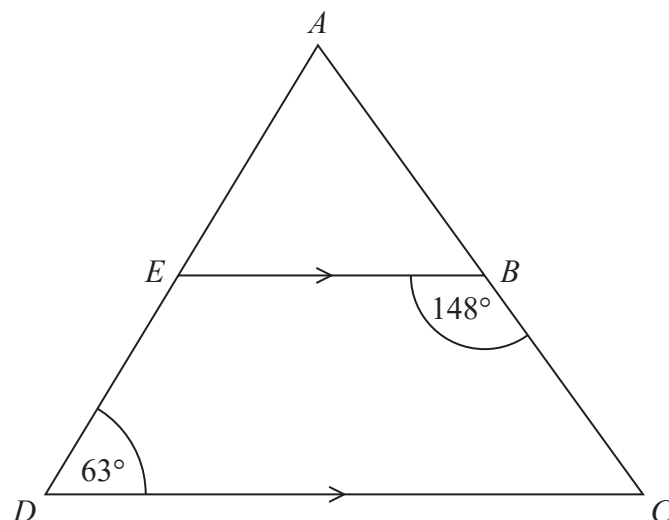

AED and ABC are straight lines.
 EB is parallel to DC .

Angle $EBC = 148^\circ$
Angle $ADC = 63^\circ$

Work out the size of angle EAB .
You must give a reason for each stage of your working.

(Total for Question 6 is 5 marks)



7 The table shows information about the heights, in cm, of a group of Year 9 girls.

least height	150 cm
median	165 cm
greatest height	170 cm

This stem and leaf diagram shows information about the heights, in cm, of a group of 15 Year 9 boys.

15	8 9 9
16	4 5 7 7 8
17	0 3 4 4 7
18	0 2

Key: 15 | 8 represents 158 cm

Compare the distribution of the heights of the girls with the distribution of the heights of the boys.

.....

.....

.....

.....

.....

.....

(Total for Question 7 is 3 marks)



DO NOT WRITE IN THIS AREA

DO NOT WRITE IN THIS AREA

DO NOT WRITE IN THIS AREA

8 The diagram shows a prism placed on a horizontal floor.

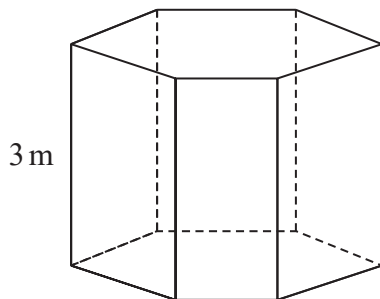

$$\text{pressure} = \frac{\text{force}}{\text{area}}$$

The prism has height 3 m
 The volume of the prism is 18 m^3

The pressure on the floor due to the prism is 75 newtons/m^2

Work out the force exerted by the prism on the floor.

..... newtons

(Total for Question 8 is 3 marks)

9 Write these numbers in order of size.
 Start with the smallest number.

- 6.72×10^5 67.2×10^{-4} 672×10^4 0.000672

.....

(Total for Question 9 is 2 marks)



10 Given that $\frac{a}{b} = \frac{2}{5}$ and $\frac{b}{c} = \frac{3}{4}$

find $a:b:c$

.....
(Total for Question 10 is 3 marks)

DO NOT WRITE IN THIS AREA

DO NOT WRITE IN THIS AREA

DO NOT WRITE IN THIS AREA



DO NOT WRITE IN THIS AREA

DO NOT WRITE IN THIS AREA

DO NOT WRITE IN THIS AREA

11 (a) Find the value of $\sqrt[4]{81 \times 10^8}$

.....
(2)

(b) Find the value of $64^{-\frac{1}{2}}$

.....
(2)

(c) Write $\frac{3^n}{9^{n-1}}$ as a power of 3

.....
(2)

(Total for Question 11 is 6 marks)



P 6 2 2 7 7 R A 0 9 2 0

12 The table gives information about the weekly wages of 80 people.

Wage (£ w)	Frequency
$200 < w \leq 250$	5
$250 < w \leq 300$	10
$300 < w \leq 350$	20
$350 < w \leq 400$	20
$400 < w \leq 450$	15
$450 < w \leq 500$	10

(a) Complete the cumulative frequency table.

Wage (£ w)	Cumulative frequency
$200 < w \leq 250$	
$200 < w \leq 300$	
$200 < w \leq 350$	
$200 < w \leq 400$	
$200 < w \leq 450$	
$200 < w \leq 500$	

(1)

(b) On the grid opposite, draw a cumulative frequency graph for your completed table.

(2)

Juan says

“60% of this group of people have a weekly wage of £360 or less.”

(c) Is Juan correct?

You must show how you get your answer.

(3)



DO NOT WRITE IN THIS AREA

DO NOT WRITE IN THIS AREA

DO NOT WRITE IN THIS AREA

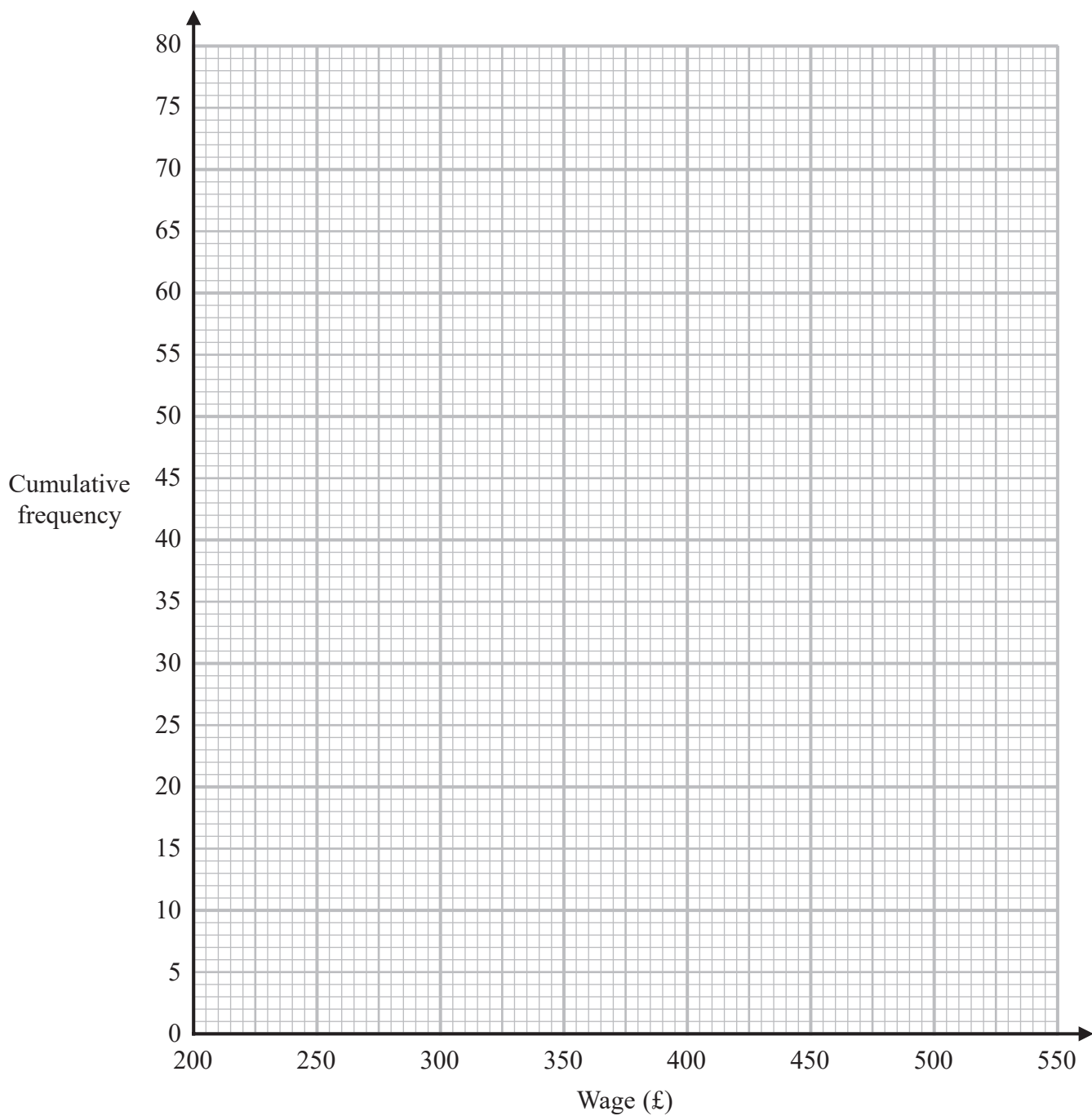

(Total for Question 12 is 6 marks)



P 6 2 2 7 7 R A 0 1 1 2 0

13 Liquid **A** and liquid **B** are mixed to make liquid **C**.

Liquid **A** has a density of 70 kg/m^3

Liquid **A** has a mass of 1400 kg

Liquid **B** has a density of 280 kg/m^3

Liquid **B** has a volume of 30 m^3

Work out the density of liquid **C**.

..... kg/m^3

(Total for Question 13 is 3 marks)

DO NOT WRITE IN THIS AREA

DO NOT WRITE IN THIS AREA

DO NOT WRITE IN THIS AREA



- 14 Sally plays two games against Martin.
In each game, Sally could win, draw or lose.

In each game they play,
the probability that Sally will win against Martin is 0.3
the probability that Sally will draw against Martin is 0.1

Work out the probability that Sally will win **exactly** one of the two games against Martin.

.....
(Total for Question 14 is 3 marks)

- 15 The straight line L_1 has equation $y = 3x - 4$
The straight line L_2 is perpendicular to L_1 and passes through the point (9, 5)
Find an equation of line L_2

.....
(Total for Question 15 is 3 marks)



16 Shirley wants to find an estimate for the number of bees in her hive.

On Monday she catches 90 of the bees.
She puts a mark on each bee and returns them to her hive.

On Tuesday she catches 120 of the bees.
She finds that 20 of these bees have been marked.

(a) Work out an estimate for the total number of bees in her hive.

.....
(3)

Shirley assumes that none of the marks had rubbed off between Monday and Tuesday.

(b) If Shirley's assumption is wrong, explain what effect this would have on your answer to part (a).

.....
.....
.....
(1)

(Total for Question 16 is 4 marks)



DO NOT WRITE IN THIS AREA

DO NOT WRITE IN THIS AREA

DO NOT WRITE IN THIS AREA

17 Make f the subject of the formula $d = \frac{3(1-f)}{f-4}$

.....
(Total for Question 17 is 4 marks)

18 x is proportional to \sqrt{y} where $y > 0$
 y is increased by 44%
Work out the percentage increase in x .

.....%
(Total for Question 18 is 3 marks)



19 f and g are functions such that

$$f(x) = \frac{12}{\sqrt{x}} \quad \text{and} \quad g(x) = 3(2x + 1)$$

(a) Find $g(5)$

.....
(1)

(b) Find $gf(9)$

.....
(2)

(c) Find $g^{-1}(6)$

.....
(2)

(Total for Question 19 is 5 marks)



DO NOT WRITE IN THIS AREA

DO NOT WRITE IN THIS AREA

DO NOT WRITE IN THIS AREA

20 Show that $\frac{\sqrt{180} - 2\sqrt{5}}{5\sqrt{5} - 5}$ can be written in the form $a + \frac{\sqrt{5}}{b}$ where a and b are integers.

(Total for Question 20 is 4 marks)



21 DEF is a triangle.

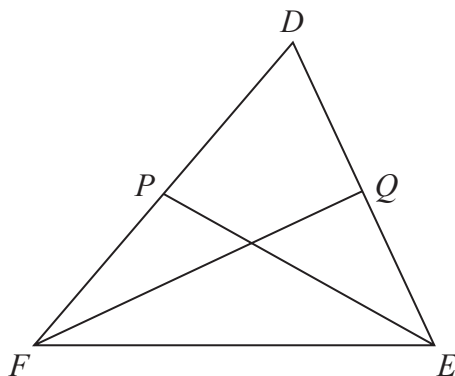

P is the midpoint of FD .
 Q is the midpoint of DE .

$$\vec{FD} = \mathbf{a} \quad \text{and} \quad \vec{FE} = \mathbf{b}$$

Use a vector method to prove that PQ is parallel to FE .

(Total for Question 21 is 4 marks)



DO NOT WRITE IN THIS AREA

DO NOT WRITE IN THIS AREA

DO NOT WRITE IN THIS AREA

22 The diagram shows two shaded shapes, A and B.

Shape A is formed by removing a sector of a circle with radius $(3x - 1)$ cm from a sector of the circle with radius $(5x - 1)$ cm.

Shape B is a circle of diameter $(2 - 2x)$ cm.

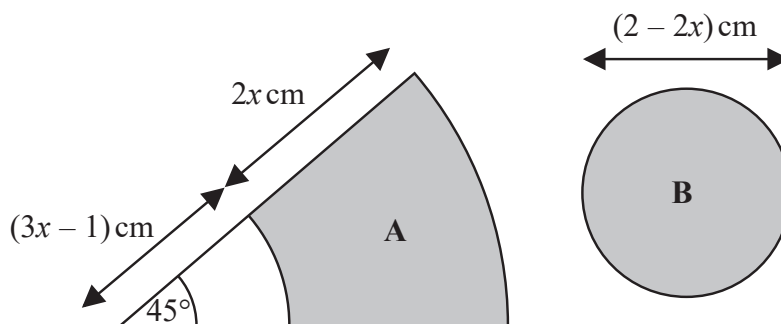

The area of shape A is equal to the area of shape B.

Find the value of x .

You must show all your working.

(Total for Question 22 is 5 marks)



23 There are four types of cards in a game.

Each card has a black circle or a white circle or a black triangle or a white triangle.

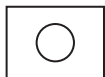

$$\begin{array}{l} \text{number of cards} \\ \text{with a black shape} \end{array} : \begin{array}{l} \text{number of cards} \\ \text{with a white shape} \end{array} = 3:5$$

$$\begin{array}{l} \text{number of cards} \\ \text{with a circle} \end{array} : \begin{array}{l} \text{number of cards} \\ \text{with a triangle} \end{array} = 2:7$$

Express the total number of cards with a black shape as a fraction of the total number of cards with a triangle.

(Total for Question 23 is 3 marks)

TOTAL FOR PAPER IS 80 MARKS

DO NOT WRITE IN THIS AREA

DO NOT WRITE IN THIS AREA

DO NOT WRITE IN THIS AREA

